

HL132.1/30

Waschtisch-Siphon DN32x5/4" mit Waschgeräte-Anschluss und Rosette

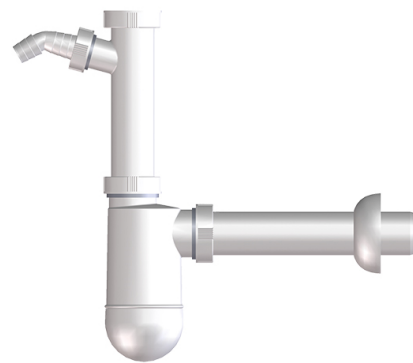

HL132.1/30 Waschtischsiphon DN32 mit
höhenverstellbarem Tauchrohr mit Anschlussgewinde
5/4" und rückflussgesichertem Waschgeräteanschluss
3/4" sowie Rosette



Techn. Zeichnung

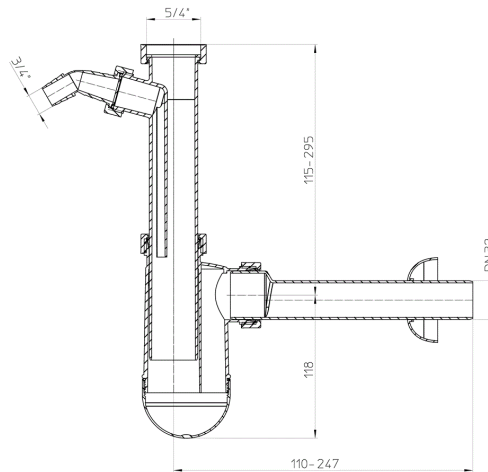





TECHNISCHE DATEN

Material	PP	Einbauhöhe
Dimension	DN32 x 5/4"	Aufsatz
Leistung		Einlaufrost
Gewicht	0,22	Belastungsklasse



HAUPTDATEN**Ersatzteile**

-  **HL01007D**
Keildichtung T30
-  **HL0130.2E**
Siphonrohr DN32
-  **HL0130.3E**
Rosette DN32
-  **HL13/30**
Tauchrohr DN32x5/4" mit Waschgeräte-Anschluss
-  **HL01001D**
Flachdichtung 5/4"
-  **HL02.3E**
Rückflusssicherung komplett
-  **HL19**
Waschgeräte-Anschlussknie 1 x 3/4 Zoll
-  **HL01050D**
O-Ring 18x2,5mm
-  **HL0400.7E**
Dichtstopfen

Zubehör

-  **HL12.3**
Gewinding 6/4"x5/4"
-  **HL13G/30**
Tauchrohr DN32x5/4"
-  **HL5/30**
Messing-Lötstutzen DN32
-  **HL902T/30**
Rohrbelüfter 1" mit T-Stück DN32x5/4"

Alternativteile

-  **HL132/30**
Waschtisch-Siphon DN32x5/4" mit Rosette
-  **HL19T/30**
T-Stück DN32x5/4" mit HL19